

Ersatzteilbestellblatt Verteilereinzelteile

Für einen ordnungsgemäßen Betrieb eines Verteilers ist das vertikale Stichmaß „c“ (siehe Abb.1) entscheidend. Bitte vergleichen Sie Ihre Maße mit denen aus der untenstehenden Tabelle.

Das Ventil funktioniert nur in Verbindung mit dem passenden Anschlussnippel. Bitte beachten Sie, dass der zugehörige Stellantrieb einen ausreichenden Hub vorweisen muss.



Abb. 1 vertikales Stichmaß eines Verteilerbalkens

1 Thermostatventileinsatz

a [Zoll]	b [mm]	c [mm]	Typ	Bestell-Nr.	Bestell-Nr. Anschlussnippel
3/8	36	38	TVE-F	3842002.076	3842002.060
3/8	36	38	TVE3/8"-ST-ni	3842604803	3842604831
3/8	33	35	TVE	3842001.076	3842002.060
1/2	41	41	TVE1/2"	3842000.076	3842000.060

2 Regulierventileinsatz

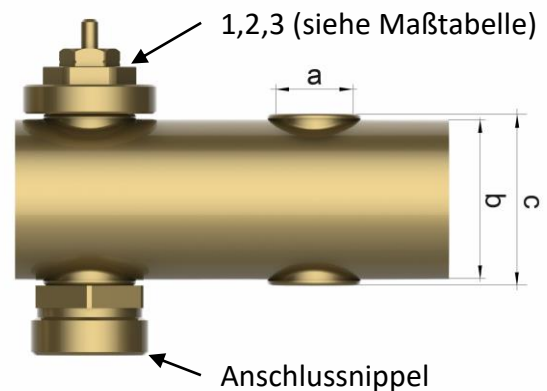
a [Zoll]	b [mm]	c [mm]	Typ	Bestell-Nr.	Bestell-Nr. Anschlussnippel
3/8	36	38	RVE-F	3842002.061	3842002.060
3/8	33	35	RVE	3842000.062	3842002.060
1/2	41	41	RVE	3842000.061	3842000.060

3 Durchflussmessereinsatz

a [Zoll]	b [mm]	c [mm]	Durchfluss [l/min]	Typ	Bestell-Nr.	Bestell-Nr. Anschlussnippel
3/8	36	38	0 – 3	TMER3/8"-ST	3842005.054	3842005.160
3/8	36	38	0 – 3	TMER3/8"-ST-ni	3842604891	3842604871
3/8	36	38	0 - 2,5	TMER3/8"-2,5	3842005.057	3842054.781
3/8	36	38	0 – 5	TMER3/8"-5,0	3842005.056	3842054.781
3/8	36	38	0 – 8	TMER3/8"-8,0	3842005.058	3842054.781
3/8	33	35	0 - 6	TMER3/8"-ST	3842003.054	3842003.060
3/8	33	35	0 – 2,5 (für RL)	TMER-F	3842004.054	3842005.060
1/2	41	41	0 - 3	TMER	3842002.054	n.v.
1/2	41	41	0 – 2,4 (für RL)	TMER 1/2"	3842000.054	n.v.

Ersatzteile Thermostatventileinsätze

Frasa - Verteiler 36 mm Durchmesser



Ersatzteile

Typ	Best.Nr.
TVE-F	3842002.076
AN3/8"-F	3842002.060

Edelstahl - Verteiler 36 mm Durchmesser



Typ	Best.Nr.
TVE3/8"-ST-ni	3842604803
AN3/8"-STK-ni	3842604831

Rund - Verteiler 33 mm Durchmesser



Typ	Best.Nr.
TVE	3842001.076
AN3/8"-F	3842002.060

Profil - Verteiler 41 mm



Typ	Best.Nr.
TVE-1/2"	3842000.076
AN1/2"	3842000.060

Ersatzteile Regulierventileinsätze

Frasa - Verteiler 36 mm Durchmesser



Ersatzteile

Typ	Best.Nr.
RVE-F	3842002.061
AN3/8"-F	3842002.060

Rund - Verteiler 33 mm Durchmesser



Typ	Best.Nr.
RVE	3842000.062
AN3/8"-F	3842002.060

Profil - Verteiler 41 mm



Typ	Best.Nr.
RVE	3842000.061
AN1/2"	3842000.060

Ersatzteile Durchflussmessereinsätze

Frasa - Verteiler 3/8" 36 mm Durchmesser

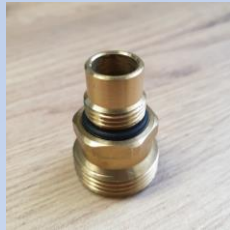
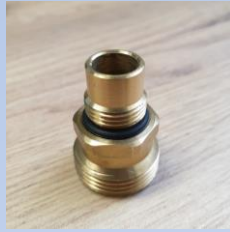

Ersatzteile

Typ	Best.Nr.
TMER3/8"-ST	3842005.054
AN3/8"	3842005.160

Typ	Best.Nr.
TMER-F	3842004.054
AN3/8"	3842005.160

Edelstahl - Verteiler 3/8" 36 mm Durchmesser

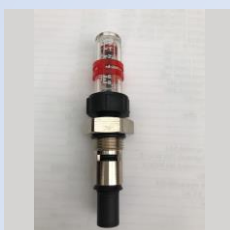
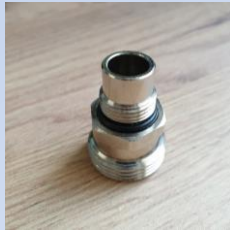

Typ	Best.Nr.
TMER3/8"-ST-ni	3842604891
AN3/8"-STL-ni	3842604871

Typ	Best.Nr.
TMER3/8"-5,0	3842005.056
AN3/8"-TACO	3842054.781

Typ	Best.Nr.
TMER3/8"-2,5	3842005.057
AN3/8"-TACO	3842054.781

Typ	Best.Nr.
TMER3/8"-8,0	3842005.058
AN3/8"-TACO	3842054.781

Ersatzteile Durchflussmessereinsätze

Rund - Verteiler 3/8" 33 mm Durchmesser



Typ	Best.Nr.
TVE	3842003.054
AN3/8"-F	3842003.060

Profil - Verteiler 1/2" 41 mm

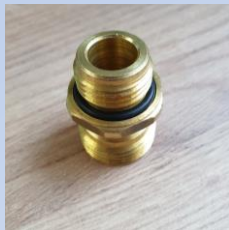
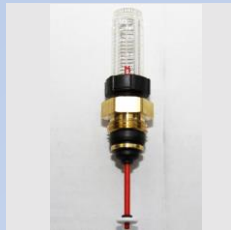

Typ	Best.Nr.
TMER1/2"	3842000.054
n.v.	n.v.



Typ	Best.Nr.
TMER	3842002.054
n.v.	n.v.